

ACCURATE MOLD-FILLING SIMULATIONS RESOLVE INJECTION-MOLDING DESIGN AND PRODUCTION CHALLENGES

White Paper

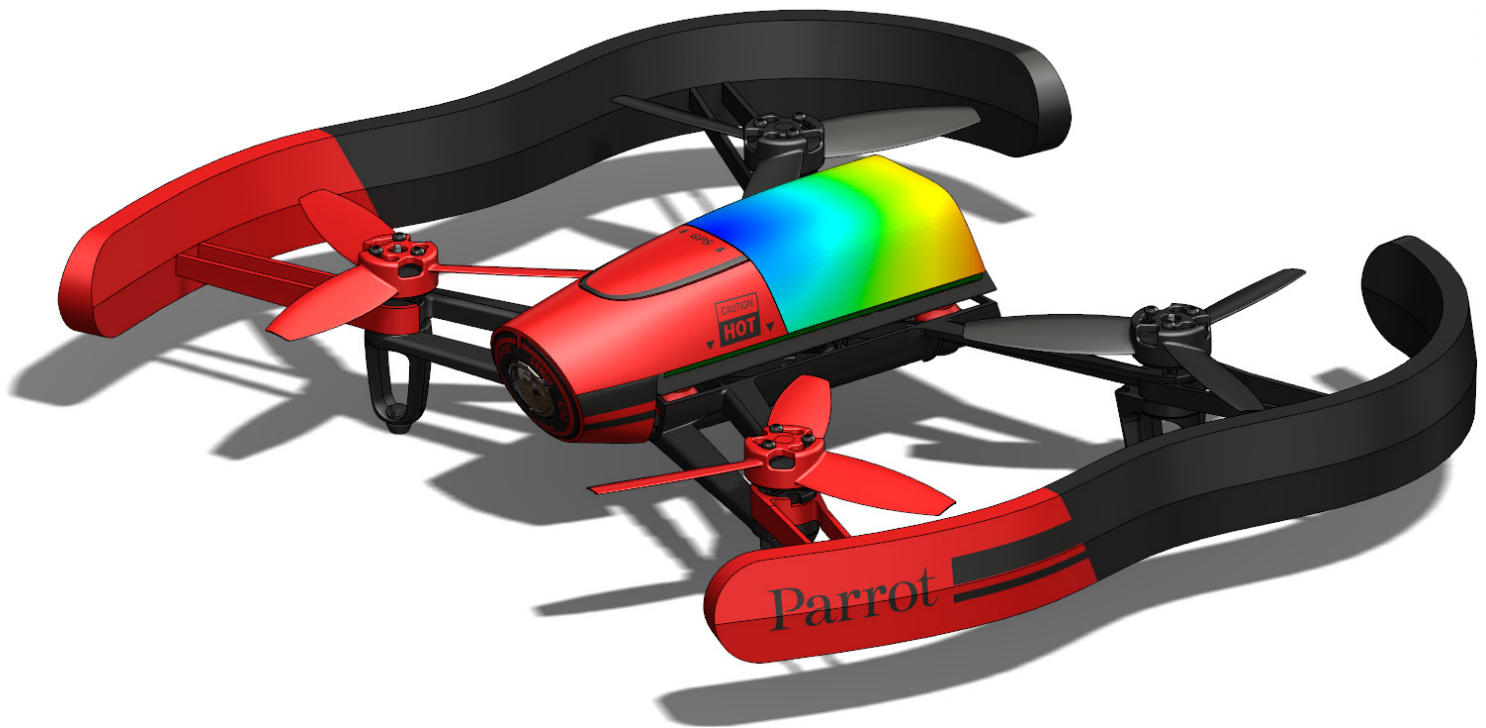

SUMMARY

Manufacturers of products with injection-molded parts can resolve design and tooling challenges by performing accurate mold-filling simulations using SOLIDWORKS® Plastics software. Rather than rely on time-consuming and costly prototyping and tooling iterations to improve manufacturability, injection-molding professionals can utilize this solution to cut time and cost from the process while simultaneously improving quality. To demonstrate the accuracy of SOLIDWORKS Plastics simulations—and validate the application’s viability for accelerating injection-molded part design and production—Dassault Systèmes initiated a project with the University of Massachusetts Lowell, one of the world’s leading plastics engineering research centers, to compare mold-filling simulation predictions with the results of actual physical tests. This paper examines the project’s findings, which validate how accurate SOLIDWORKS Plastics mold-filling simulations can streamline injection-molded part and tooling development.

ENSURE TIMELY, COST-EFFECTIVE INJECTION MOLDING WITH ACCURATE MOLD-FILLING SIMULATIONS

Lighter parts. Less scrap. More affordable materials. Greater design flexibility. These are some of the reasons why manufacturers have increasingly turned to plastic materials to develop new products and why the use of injection-molding manufacturing processes has expanded every year for the past half century. Plastic injection molding manufacturing has grown from a niche application for producing simple products like buttons and combs to a strategic, sophisticated process for making a variety of components and products of increasing complexity in industries ranging from automotive, medical, and aerospace to consumer products, toys, and packaging.

As more of today's leading manufacturers look to plastic materials to produce better alternatives to conventionally machined metal parts, the efficiency and quality of injection molding processes becomes critically important because more than 80 percent of plastic parts have to be injection molded. With more manufacturers leveraging injection-molding technology, companies that consistently produce high-quality injection-molded parts more quickly and at lower cost have a distinct competitive advantage.

Until recently, developing part and tooling designs for injection molding manufacturing required a tedious, iterative prototyping process to eliminate potential manufacturing defects through trial and error. While this approach enables manufacturers to resolve manufacturability and tooling issues that can lead to defects—such as air traps, voids, poorly placed parting lines, shrinkage, warpage, surface blemishes, structural weaknesses, and large part deformation—it also adds time and cost to the process. What's really needed to streamline injection-molded component and tooling development is the ability to perform the trial-and-error-driven prototyping process in an accurate, virtual environment.

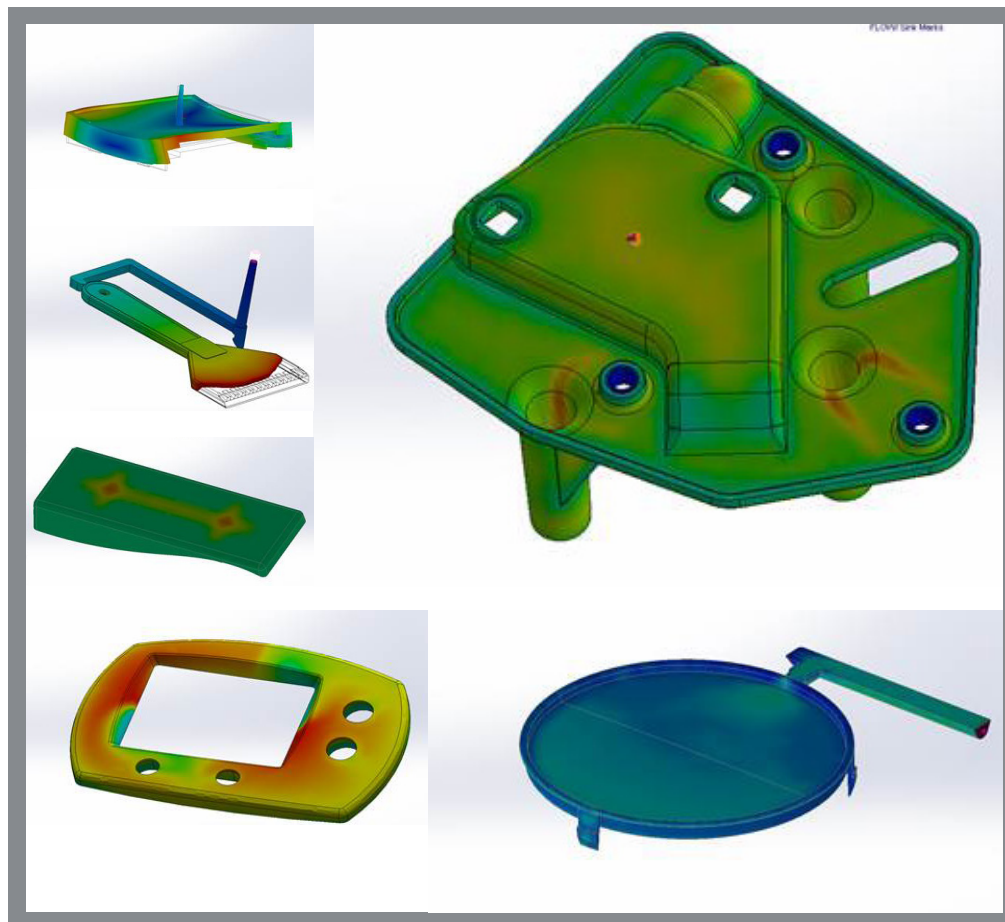

Examples of plastic part design flaws identified in SOLIDWORKS Plastics. Starting clockwise: sink marks, shear stresses, uneven cooling, sink marks, short shot, and warpage.

Creating tooling that produces quality injection-molded parts involves several variables. What is the optimal temperature of the melted plastic that is injected into the mold, as well as of the mold itself? Are cooling channels adequate to support these temperatures, and if not, how should they be configured? What's the best thermoplastic material to use for a specific design? At what pressure and flow rate should the plastic material be injected into the mold to facilitate filling and packing? How long should the part be left in the mold to solidify before ejection? Will specialized tooling—inserts, side actions, additional injection gates, secondary operations, or innovative cooling channel layouts—shorten cycle times or eliminate defects?

These are the questions to which plastic part designers, moldmakers, and injection-molding manufacturing professionals need answers in order to produce tooling that minimizes quality issues, and the reasons why prototype mold iterations are necessary. If only injection-molding professionals had an accurate way to predict how the many variables that influence production affect shooting, cooling, and ejecting a particular part, they wouldn't have to invest the time and money associated with iterative prototyping. This is why accurate mold-filling simulations are so beneficial: because they support the same trial-and-error process for discovering the right combination of variables required to produce quality injection-molded parts in computer software, which is both faster and less costly.

With accurate mold-filling simulation capabilities, product designers can balance design aesthetics against manufacturability, moldmakers can optimize tooling without needing to create prototype molds, and manufacturing professionals can shorten run cycles, all of which saves time, reduces costs, and boosts quality. The key factor for avoiding the conventional mold prototyping process rests with the accuracy of mold-filling simulations.

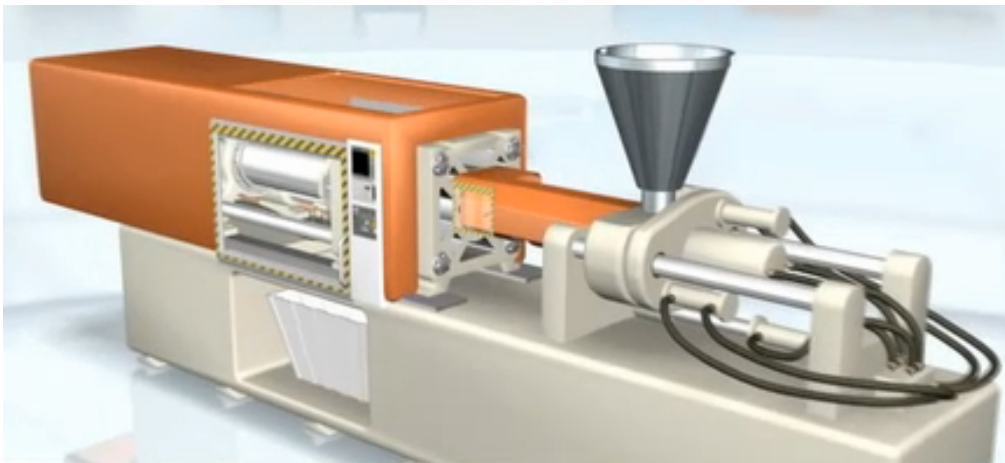

The SOLIDWORKS Plastics mold-filling simulation accuracy studies were conducted by the renowned Plastics Engineering Department at the University of Massachusetts Lowell on the molds used to produce these three parts: a typical electronics housing, a cap for a medical product, and a radon detector housing.

Image courtesy of Routsis Training
<http://www.traininteractive.com>

Mold-Filling Accuracy Studies on Diverse Plastic Parts

To demonstrate the high degree of accuracy of mold-filling simulations conducted with SOLIDWORKS Plastics software, Dassault Systèmes asked the renowned Plastics Engineering Department at the University of Massachusetts Lowell (UMass Lowell) to conduct a series of physical experiments on three specific part and mold designs: a typical electronics housing, a cap for a medical product, and a radon detector housing. These molds were chosen for their diversity and unique characteristics in order to broaden the reach of the study and the import of its results.

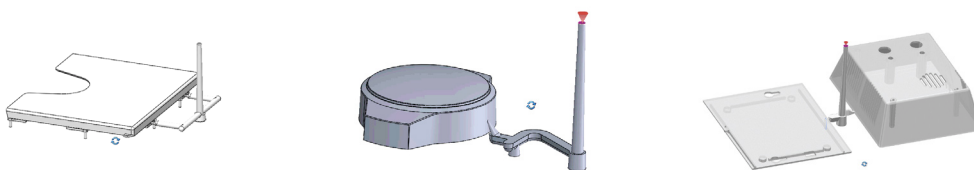

While plastics injection molding systems vary, they all involve an injection/heating, clamping, mold, and control systems.

The project involved shooting parts from these three molds while using laser-based instrumentation, precision timepieces, and machine readings to document the key variables related to filling, packing, cooling, and warping, including temperatures, time, clamp forces, pressures, and flow rates. Experiments related to short shots, gate imbalances, gate freeze, weld lines, structural weakness, filling evolution, and strip-mold ejection issues were also conducted. The experimental work was performed by Professor Stephen Johnston at UMass Lowell using Arburg and Sumitomo injection molding machines.

The findings of these physical experiments were then compared to the results predicted by SOLIDWORKS Plastics mold-filling simulations, using parameters set to match the specific injection-molding machine used. This comparison showed a close correlation—within ± 10 percent—between simulation and actual results. These findings validate the efficacy of using SOLIDWORKS Plastics mold-filling simulation software for streamlining and accelerating injection-molded part and tooling development.

Electronics Housing

For the electronics housing, a twin-gate mold was shot with a polypropylene plastic. In addition to documenting key variables during cooling, filling, packing, and warping, the experiment compared the position of weld lines associated with the twin-gate approach and their impact on structural integrity, as well as a series of short shots to validate how the mold fills.



The mold used to produce the electronics housing features cooling channels for controlling temperature uniformity.

The cooling system takes the 240.6°C sprue inlet temperature down to 32°C and 34°C at two different locations inside the mold cavity. The simulation conducted with SOLIDWORKS Plastics software predicted temperatures at these two locations of 34°C and 32°C respectively.

Next, UMass Lowell conducted a series of short shots by varying the volume of material used to confirm how the plastic flows into the mold. As shown in Figure 1, the simulation results using these short shots are virtually identical to the actual short-shot parts.

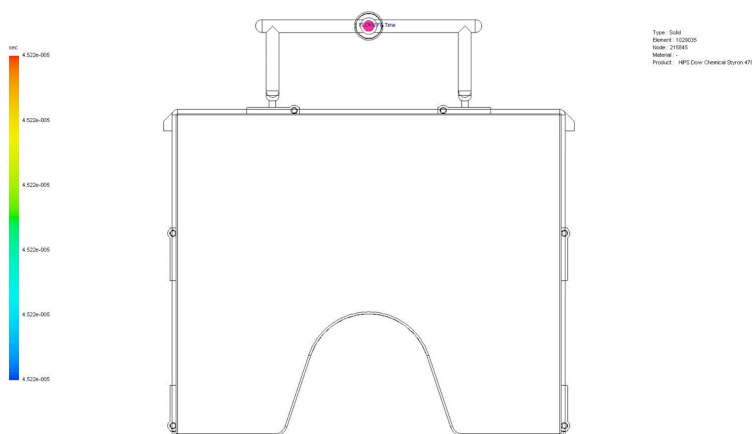

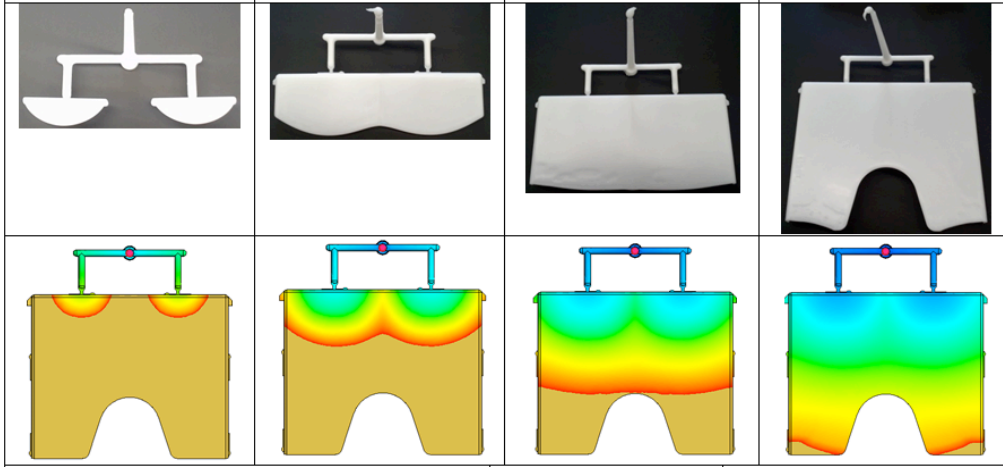

Figure 1.

Simulations run with SOLIDWORKS Plastics software predicted the position of a weld line on the ejected part, which suggested a possible structural weakness. In fact, the actual part is prone to breaking at the weld line (see Figure 2).

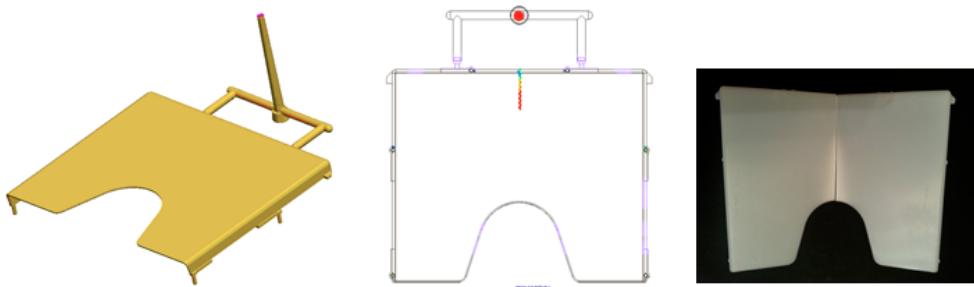

Figure 2.

During packing, gate freeze—when the material solidifies and prevents continued filling of the mold—occurred between 1 and 2 seconds during the physical experiment. The SOLIDWORKS Plastics simulation indicated that gate freeze would occur 1.7 seconds after end of fill (see Figure 3).



Figure 3.

To investigate warping, the study looked at two separate dimensions (see Figure 4) to compare shrinkage after ejection from the mold. Again, the SOLIDWORKS Plastics mold-filling simulation prediction bore a close correlation to actual results.

Part	Test	SOLIDWORKS Plastics
Dimension A	0.7 %	1.2 %
Dimension B	1.2 %	1.3 %

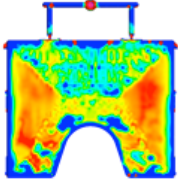

shrinkage after packing

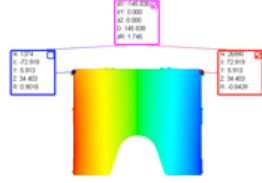

X-shrinkage after warping

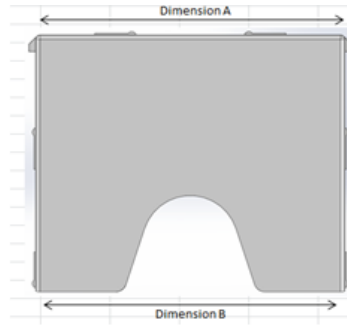
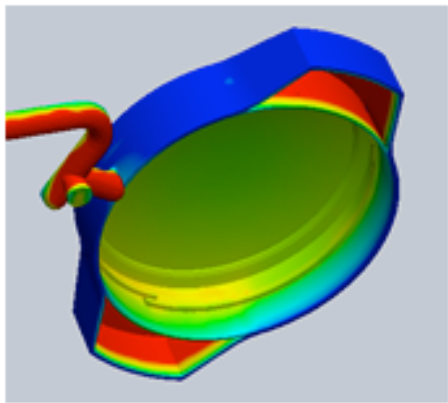

Figure 4.

Medical Cap

Unique features of the medical cap mold include the use of a beryllium-copper (Be-Cu) core insert, which helps to eliminate strip-mold ejection issues. This part has threads that are undercut and must be stripped off the tool while the part is still soft, making temperature uniformity critical. As illustrated in Figure 5, SOLIDWORKS Plastics simulations show that using just a steel mold without the Be-Cu insert results in non-uniform temperature distributions that could lead to thread fracture during part ejection. Incorporating the Be-Cu insert is precisely the type of tooling modification that SOLIDWORKS Plastics software facilitates.



Be-Cu Insert

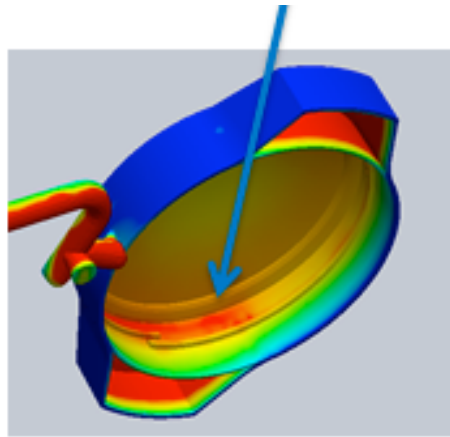

Steel Only

Figure 5.

For the medical cap, a pin-gate mold with the Be-Cu insert was shot with a polypropylene plastic (see Figure 6). The study examined temperatures during cooling, gate freeze time during packing, and a series of short shots to validate how the mold fills.

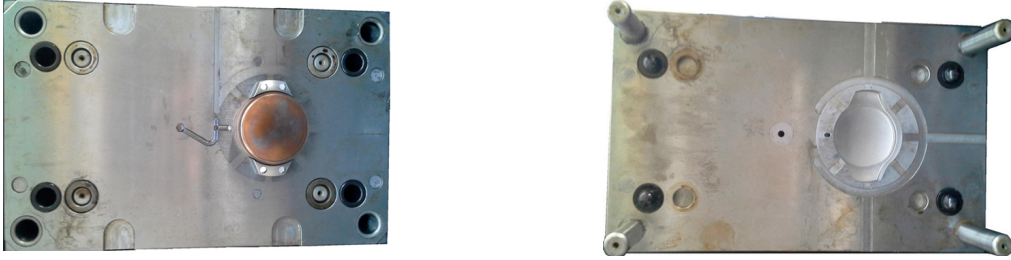

Figure 6.

During cooling, the physical experiment found a temperature range of between 28°C and 32°C at various locations around the Be-Cu insert. The SOLIDWORKS Plastics simulations predicted temperatures ranging from 28°C to 35°C at the same locations in this design. The accuracy of these simulation results validates the need for the Be-Cu insert and the uniform temperature distribution required to pull the part off the tool while it's still soft.

To examine whether the mold fills as predicted by SOLIDWORKS Plastics simulations, UMass Lowell again conducted a series of short shots by varying the volume of material injected into the mold. As illustrated in Figure 7, SOLIDWORKS Plastics simulation results closely track how the mold actually fills.

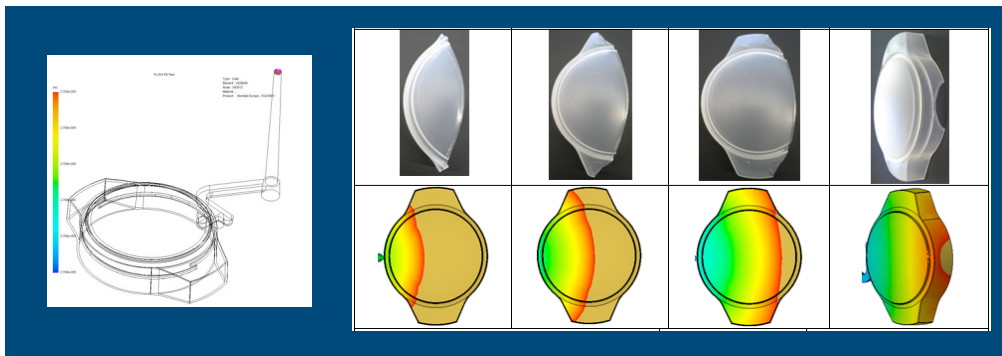

Figure 7.

This experiment also considered how long after end of fill it takes for gate freeze, or end of pack, to occur. The physical test revealed that the gate freezes at between five and six seconds. SOLIDWORKS Plastics simulations predicted gate freeze at 6.5 seconds after end of fill (see Figure 8).

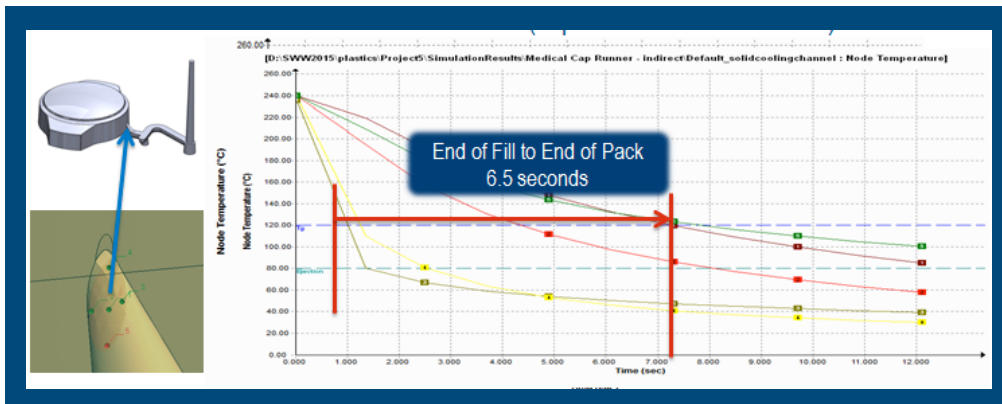

Figure 8.

Radon Detector

The tooling for the radon detector housing is an unbalanced family mold that utilizes a sophisticated arrangement of cooling channels (see Figure 9). This cooling arrangement is necessary because of the non-uniform temperature range inside the mold cavity related to the differing geometries of the two parts in this family. Understanding how temperatures vary inside a mold is important for eliminating hot spots in the part that can result in defects, delay part ejection, or slow cycle times. The insights that SOLIDWORKS Plastics simulations can provide into injection-molding challenges can lead to the development of innovative cooling systems like this one.

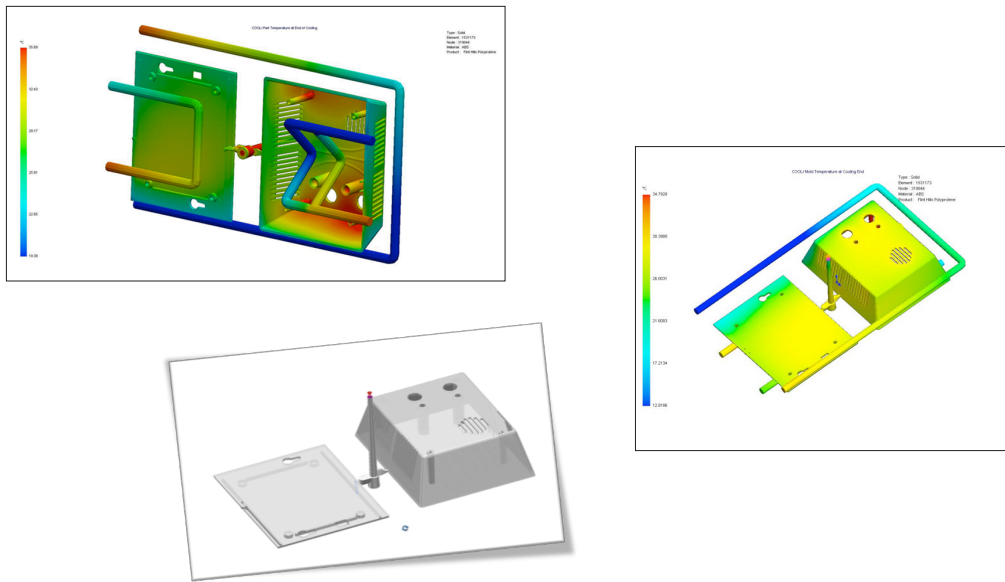

Figure 9.

For the radon director, an unbalanced family mold was shot with a polypropylene plastic. In addition to documenting key variables during cooling, filling, packing, and warping, the experiment examined how gate imbalances can result in hesitation marks, defects that can arise when one part in a family mold fills faster than the other, as well as a series of short shots to validate how the mold fills.

The unique cooling system on this mold takes the 207°C sprue inlet temperature down to between 25.2°C to 30.6°C, at different locations inside the mold cavity. The simulation conducted with SOLIDWORKS Plastics software predicted a temperature range of between 26.4°C and 30.4°C at the same locations.

As with the other two parts used for this study, UMass Lowell conducted a series of short shots by varying the volume of material used to determine how flow patterns predicted by SOLIDWORKS Plastics simulations match up with how the material actually flows into the mold. As Figure 10 shows, these simulation results align well with the findings of the physical tests.

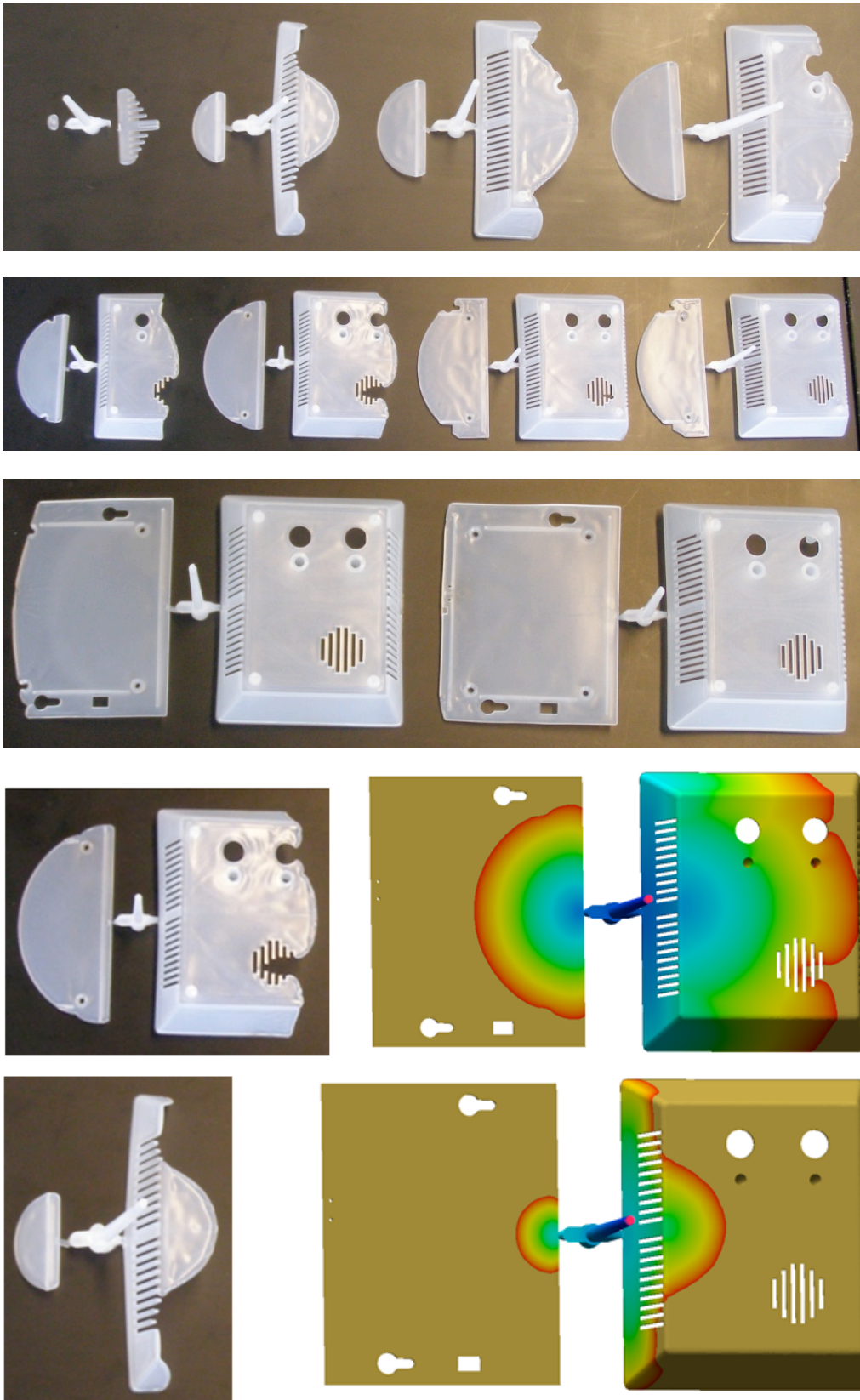

Figure 10.

SOLIDWORKS Plastics simulations both predicted the appearance of a hesitation mark defect in the smaller of the two parts that make up the radon detector housing (see Figure 11) and revealed the reason for the defect. Because the larger cavity fills first, the flow front hesitates while filling the smaller cavity. When the filling completes, a temperature difference related to the uneven filling causes the defect (see Figure 12).

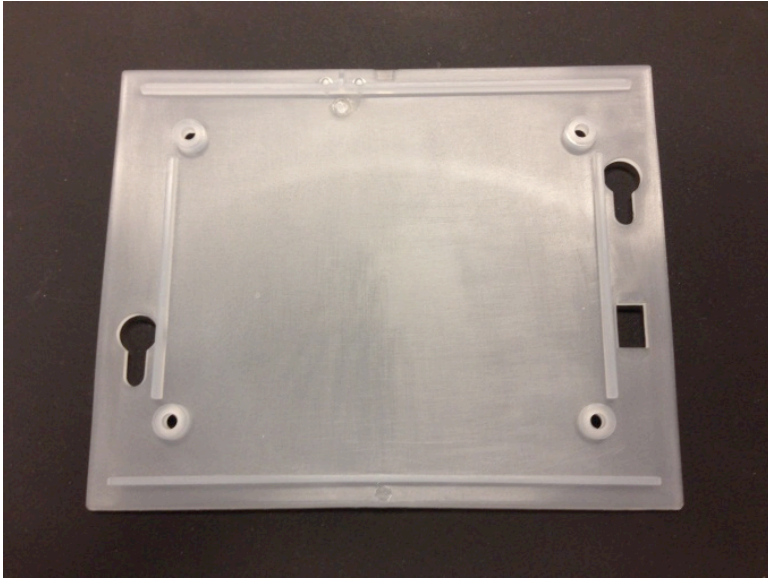

Figure 11.

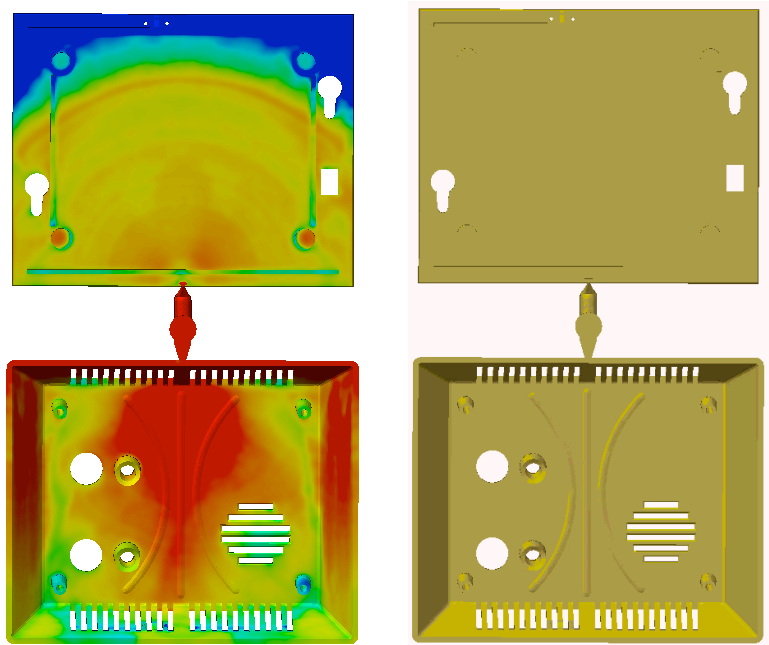

Figure 12.

Other findings of this study include comparisons of inlet pressure, gate freeze time, and part shrinkage/warpage. Experimental tests showed the maximum inlet pressure to be 50.9 MPa, while SOLIDWORKS Plastics simulations predicted 48.3 MPa; gate freeze time at four to six seconds, while SOLIDWORKS Plastics simulations predicted six seconds; and part shrinkage/warpage of 1 mm, while SOLIDWORKS Plastics simulations predicted 0.9345 mm.

ACCURATE SOLIDWORKS PLASTICS MOLD-FILLING SIMULATIONS BENEFIT PRODUCT DESIGNERS, MOLDMAKERS, AND MANUFACTURERS

By providing product designers, moldmakers, and manufacturing professionals with the ability to accurately simulate mold-filling operations, SOLIDWORKS Plastics mold-filling simulation software can more quickly and cost-effectively provide them with the insights needed to optimize designs and tooling. This solution can either replace or greatly condense mold prototyping requirements, especially when everyone associated with the development and production of injection-molded parts and tooling have access to the SOLIDWORKS Plastics simulation environment. Whether you are a product designer concerned about manufacturability, a moldmaker focused on tooling design, or a manufacturing professional interested in reducing cycle times, the SOLIDWORKS Plastics product family has solutions that can help you work smarter, faster, and better.

SOLIDWORKS Plastics for Evaluating Manufacturability

Evaluating manufacturability of a part during initial design provides designers with the opportunity to help their companies avoid design changes and production issues later in the process. SOLIDWORKS Plastics software gives designers fast, accurate answers to important questions, including will my part fill, where will the parting/weld lines appear, will there be any voids or air traps, and where will the best gate locations be? The software enables designers to simulate the mold-filling stage not so much for the purpose of developing actual tooling but for understanding whether design modifications prior to mold development will speed tooling design, accelerate production, and shorten time-to-market.

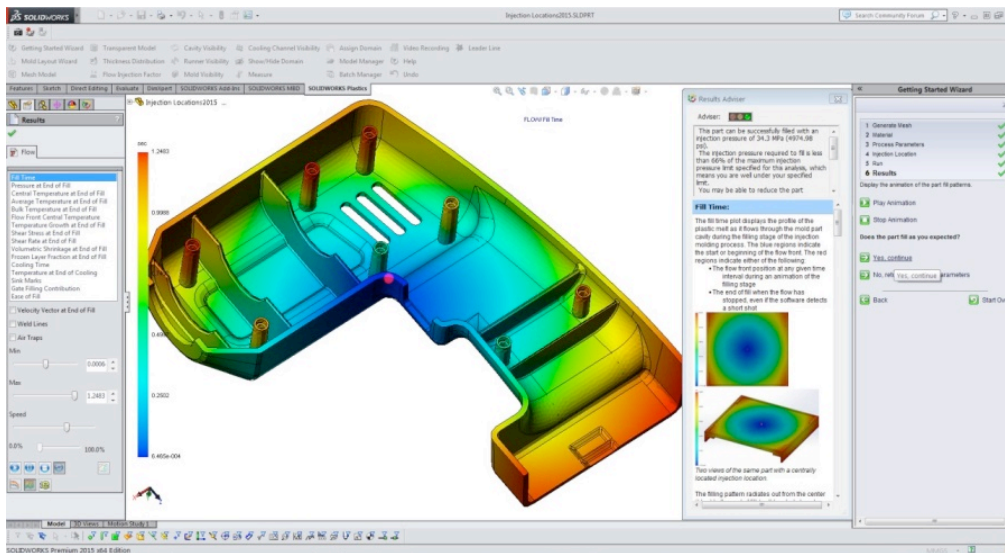

SOLIDWORKS Plastics software enables product designers to determine whether their design has manufacturability issues.

SOLIDWORKS Plastics Professional for Mold Design Optimization

Developing effective injection-molded tooling, which consistently produces high quality parts, as quickly and inexpensively as possible is the ultimate goal for all moldmakers. SOLIDWORKS Plastics Professional software provides additional, simulation tools for optimizing injection-molded tooling designs of all levels of complexity. The software allows moldmakers to accurately simulate the filling and packing phases to determine maximum injection pressure and machine size requirements; balance runner systems to achieve uniform filling and avoid defects; and estimate cycle time, clamp tonnage, and shot size to optimize feed systems. Accurately simulating the performance of tooling variations—such as whether to use single-cavity, multi-cavity, or family mold layouts; trying out different locations for sprues, runners, and gates; or evaluating advanced approaches such as inserts, valve gates, or two-shot or gas-assisted molding—allows moldmakers to create the best tooling for the job faster and more affordably.

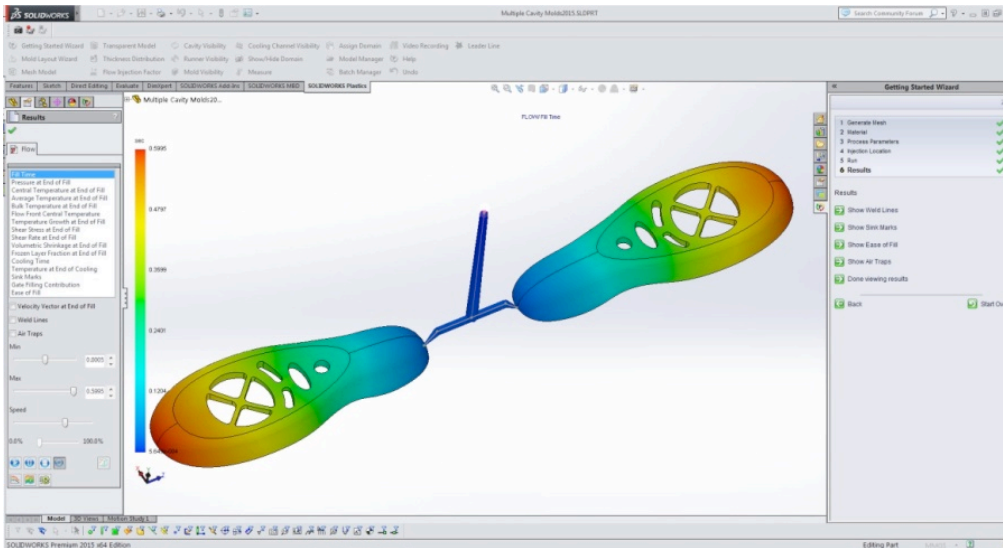

SOLIDWORKS Plastics Professional software allows moldmakers to optimize mold designs without relying on prototype molds.

SOLIDWORKS Plastics Premium for Improving Production Cycle Times

Reducing injection-molding cycle times by opening molds and ejecting high-quality parts in as short a time as possible is critically important to the success of today's manufacturing professionals. With the most advanced set of capabilities, SOLIDWORKS Plastics Premium software helps injection-molding specialists achieve the optimal balance between fast cycle times and high-quality production. The software supports the design and simulation of injection-mold cooling line layouts, the development of conformal cooling channel systems, the exploration of different types of materials, and the optimization of processing parameters to reduce or eliminate molded part warpage. By leveraging these additional simulation tools, injection-molding specialists can resolve the challenges that extend cycle times and take production to an entirely new level of performance.

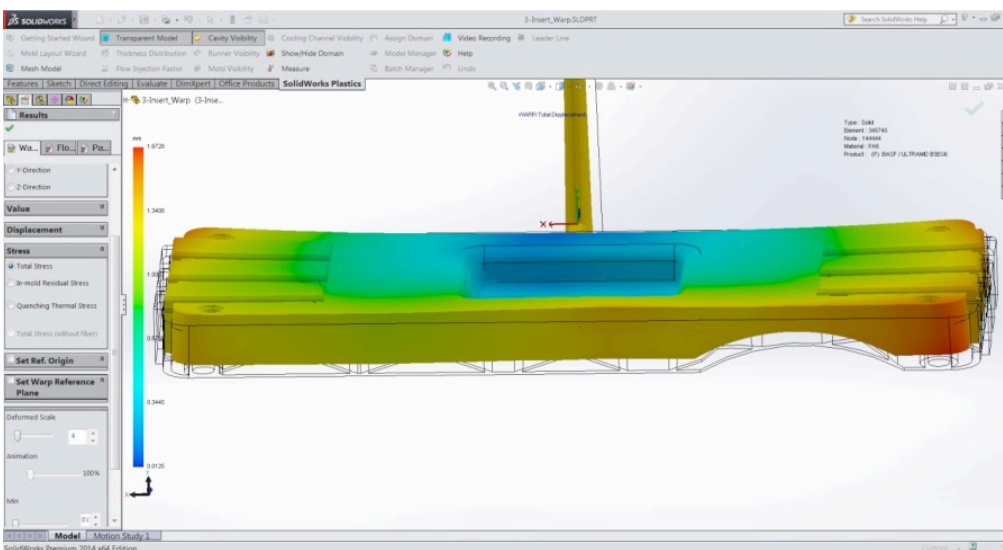

SOLIDWORKS Plastics Premium software helps injection-molded manufacturing professionals find ways to improve production cycle times.

BOOST PRODUCTIVITY WITH ACCURATE MOLD-FILLING SIMULATIONS

The growing use of injection-molded plastic parts instead of conventionally machined metal parts carries several advantages for today's manufacturers, ranging from cost, weight, and scrap reductions to greater design flexibility through the production of more complex shapes and design geometries. However, for these benefits to accrue to their greatest potential, boosting injection-molded design and tooling productivity and achieving consistently high production quality have become critically important for success. Manufacturers can increase the efficiency and performance of their injection molding operations by replacing or augmenting traditional, trial-and-error prototype mold iterations with the SOLIDWORKS Plastics mold-filling simulation solution.

As the UMass Lowell validation study shows, there's a close correlation between SOLIDWORKS Plastics simulation results and what actually happens inside of a mold. These simulations are sufficiently accurate to accelerate the trial-and-error-driven prototyping process for optimizing designs, tooling, and cycle times, while saving time and money in the process. By refining product and tooling designs in software through accurate SOLIDWORKS Plastics mold-filling simulations, manufacturers can streamline and improve injection-molded component design, tooling development, and production.

To learn more about how the accuracy of mold-filling simulations with SOLIDWORKS Plastics software can improve your injection-molding development and production processes, visit www.solidworks.com or call 1 800 693 9000 or 1 781 810 5011.

Our 3DEXPERIENCE® platform powers our brand applications, serving 12 industries, and provides a rich portfolio of industry solution experiences.

Dassault Systèmes, the 3DEXPERIENCE® Company, provides business and people with virtual universes to imagine sustainable innovations. Its world-leading solutions transform the way products are designed, produced, and supported. Dassault Systèmes' collaborative solutions foster social innovation, expanding possibilities for the virtual world to improve the real world. The group brings value to over 190,000 customers of all sizes in all industries in more than 140 countries. For more information, visit www.3ds.com.



3DEXPERIENCE®

©2014 Dassault Systèmes. All rights reserved. 3DEXPERIENCE®, the Compass icon and the 3DS logo, CATIA, SOLIDWORKS, ENOVIA, DELMIA, SIMULIA, GEODIA, NETVIBES, and 3DEXPTE are commercial trademarks or registered trademarks of Dassault Systèmes or its subsidiaries in the U.S. and/or other countries. All other trademarks are owned by their respective owners. Use of any Dassault Systèmes or its subsidiary trademarks is subject to their express written approval.



SIM Technologies Pvt. Ltd.

3rd Floor, "Mamanjee Centre",
S7-A, Thiru-Vi-Ka Industrial Estate,
Guindy, Chennai – 600 032

+91-8754447021

marketing@simtek.in